

# TOSOT COMFORT

Model: GMV-ND24G/B4B-T(U)

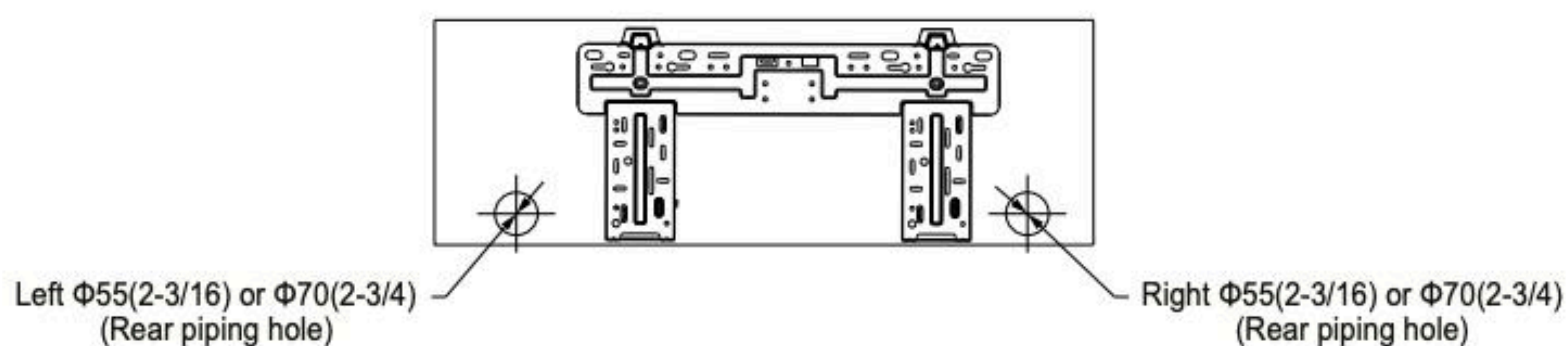
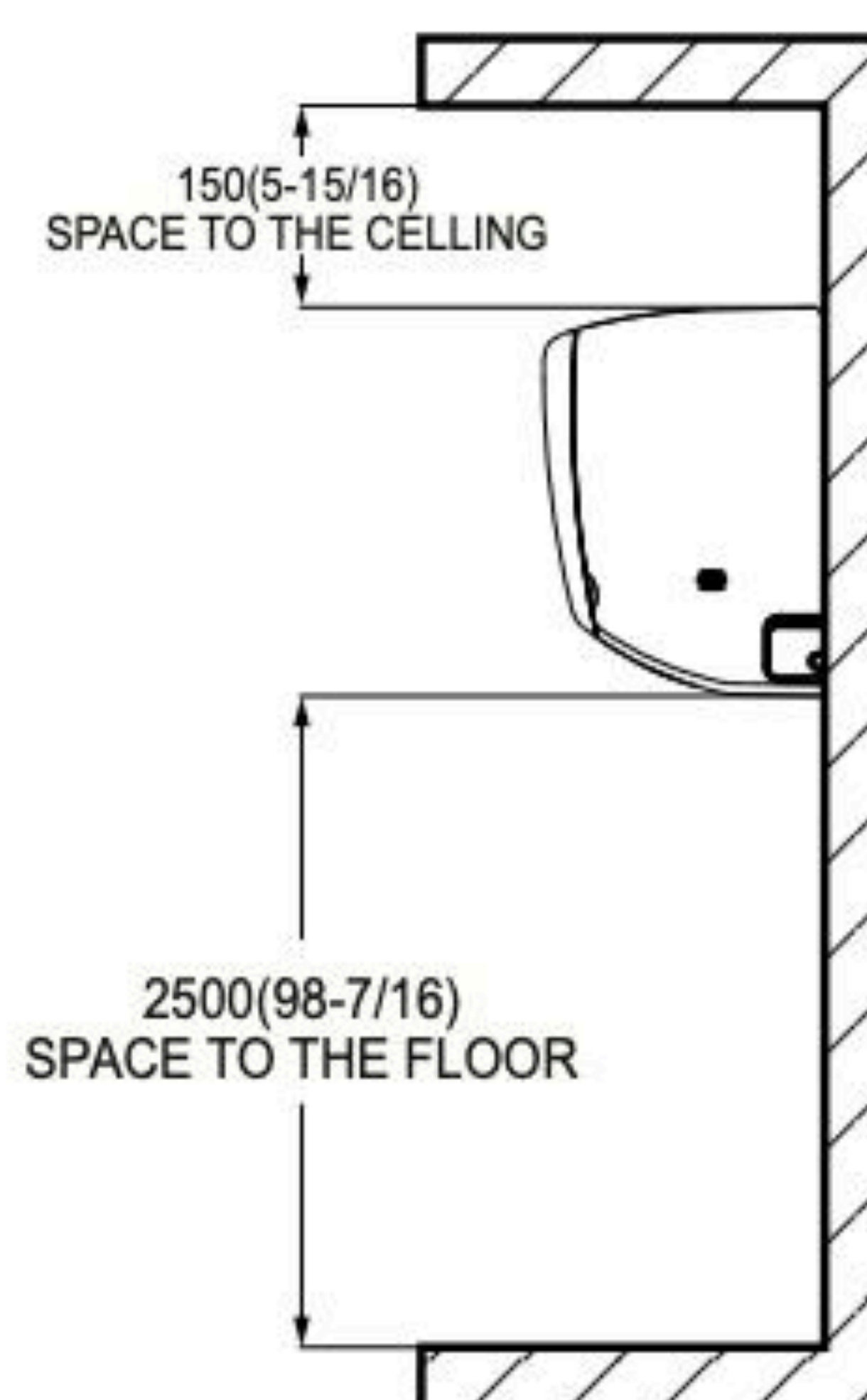
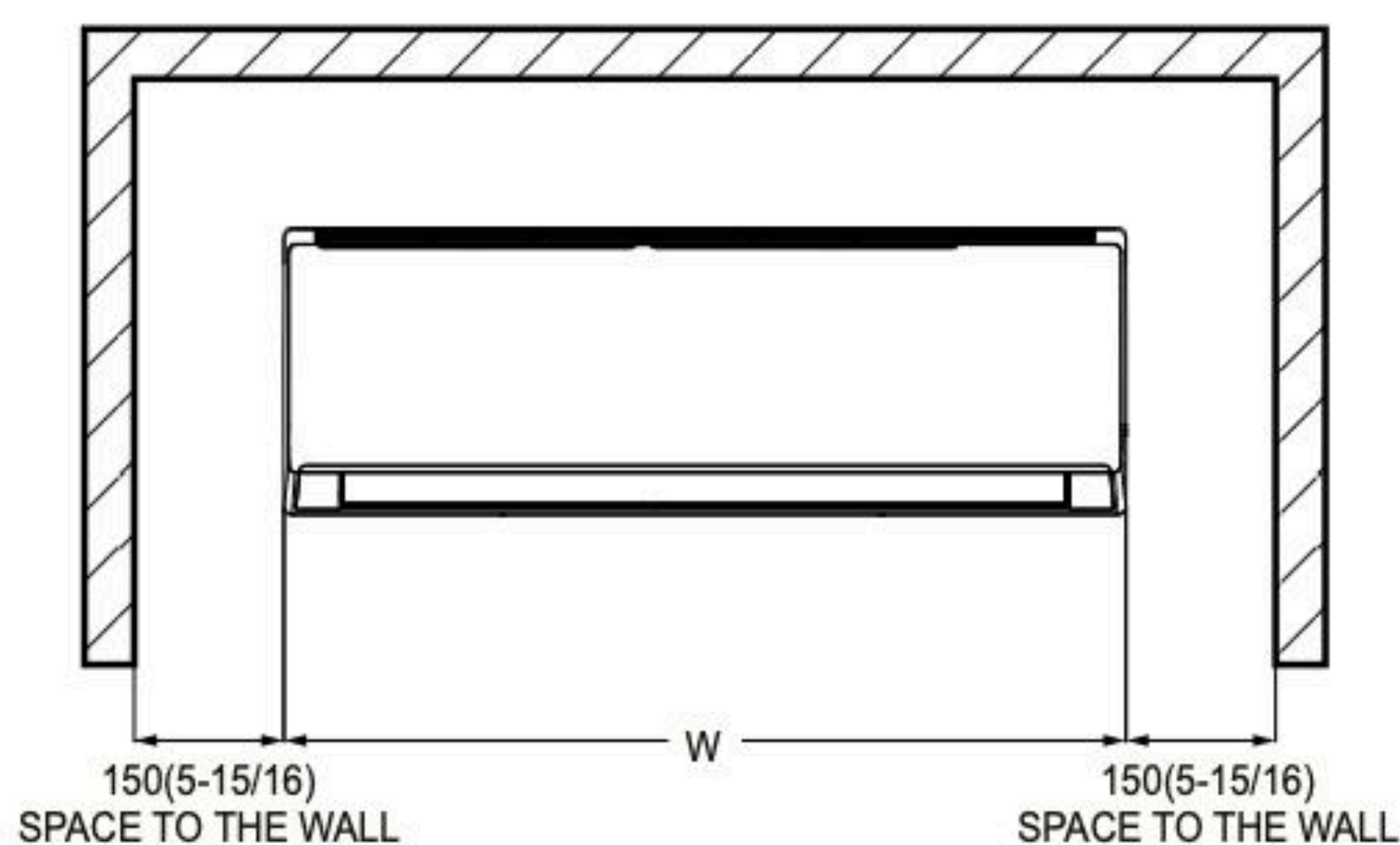
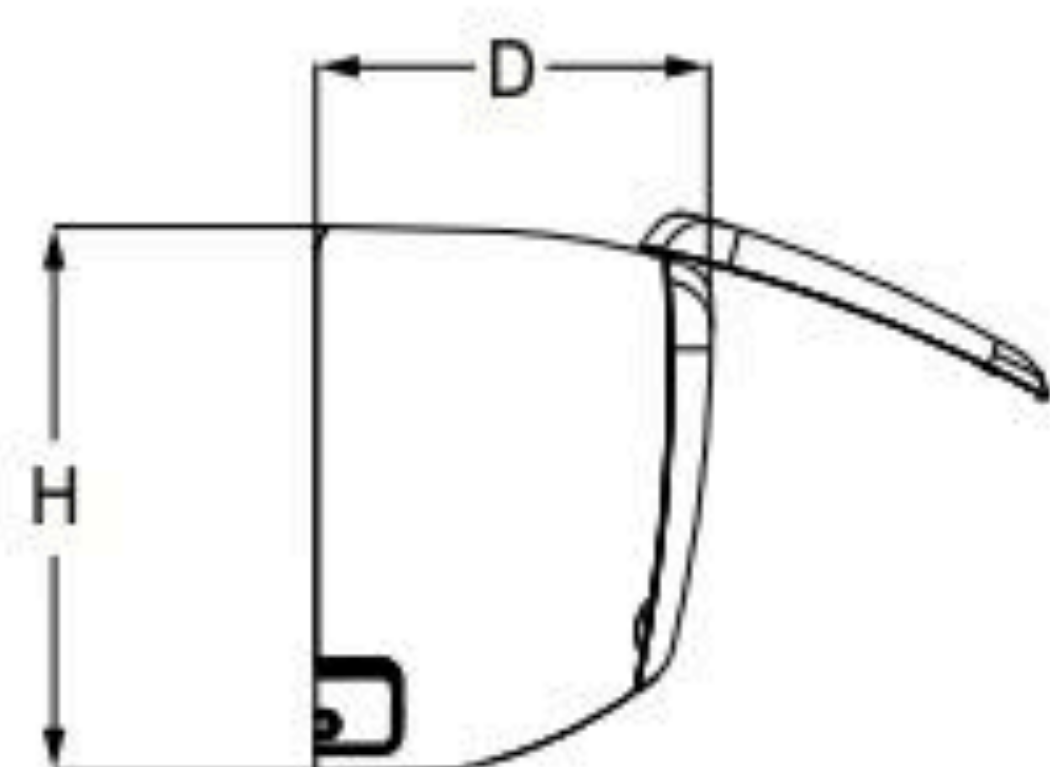

<b>Specification</b>	<b>Unit</b>	<b>Parameter</b>
<b>Performance</b>		<b>GMV-ND24G/B4B-T(U)</b>
Rated Cooling Capacity	kBtu/h	24.0
Rated Heating Capacity	kBtu./h	25.5
Sound Pressure Level (H/M/L)	dB(A)	44/41/37
<b>Fan</b>		
Type x Quantity		Cross-flow x 1
Air Flow Volume (H/M/L)	CFM	706/500/383
Fan Motor Running Current	A	0.31
Fan Motor Power Input	W	65
<b>Electrical Data</b>		
Power Supply	Voltage, Phase, Hertz	208/230, 1, 60
Minimum Circuit Amps (MCA)	A	1
Maximum Overcurrent Protection (MOP)	A	15
<b>Refrigerant Piping</b>		
Connection Pipe	Gas (inch)	5/8
	Liquid (inch)	3/8
Connection Method	Flare Connection	
Refrigerant	R410A	
<b>Dimension/Weight</b>		
Dimensions (HxWxD)	inch	42-7/16 x 12-13/16 x 9-11/16
Net Weight	lbs	35.5
<b>Other</b>		
Safety Certification		ETL

10 years warranty on parts and compressors  
[www.tosotcomfort.com](http://www.tosotcomfort.com)