

Submittal Data: LIVS18HP230V1B 18,000 BTU/H (208/230V) Wall Mounted Heat Pump System

Job Name _____ Location _____ Date _____

Purchaser _____ Engineer _____

Submitted To _____ For Reference Approval Construction

Unit Designation _____ Schedule No. _____

GENERAL FEATURES
 -High Efficiency DC Inverter Technology
 -Compact and Quiet Design
 -Wireless Remote with LCD Display
 -Wi-Fi Ready (Sold Separately Kit PN: WSBEC02)
 -XK41 Wired Prog. Controller (Sold Separately)
 -Low Ambient Cool to 0 deg F
 -Blue Fin Condenser Coil
 -5 year Limited Parts Warranty **HDULPLWHG**
RPSUHRUJDUJDDM

System Ratings

Indoor Unit Data

Cooling		
Rated Capacity		18,000 BTU/H
Capacity Range		7,165-20,001 BTU/H
Power Input (Max)		1,920 W
SEER		16.0
EER		9.0
Heating at 47° F		
Rated Capacity		19,000 BTU/H
Capacity Range		7,336-23,498 BTU/H
Power Input (Max)		2,000 W
HSPF		9.0
COP		2.8
Heating at 17° F		
Rated Capacity		12,000 BTU/H
Operating Range		
Cooling	(Max)	115°F (46 C)
	(Min)	0°F (-18 C)
Heating	(Max)	75°F (24 C)
	(Min)	-4°F (-20 C)

Fan Motor	Type	Cross-Flow
	Output Power	30 W
	FLA	0.3 A
Airflow		
Cooling	Wet (Lo/Hi)	282/471 CFM
Heating	Dry (Lo/Hi)	282/471 CFM
Sound Pressure Level		
Cooling	(Min/Max)	35/46 db(A)
Heating	(Min/Max)	35/46 db(A)
Dehumidification		3.80 pt/hr

Refrigerant Piping Data

Outdoor Unit Data

Gas Pipe Size (OD)	1/2-in
Liquid Pipe Size (OD)	1/4-in
Connection Method	Flared
Factory Charge	49.4 oz
Additional Charge	0.2 oz/ft
Pre-Charge Length	25-ft
MAX Refrigerant Pipe Length	82-ft
MIN Refrigerant Pipe Length	10-ft
MAX Refrigerant Pipe Elevation	33-ft

Compressor	Type	DC Inverter Driven Rotary
	RLA	12.1 A
Refrigerant Type		R410A
Fan Motor	Output Power	60 W
	FLA	0.52 A
Sound Pressure		
Cooling/Heating		56/56 db(A)

Electrical Data

Power Supply		
Normal Operational Voltage		208/230 V, 1 Phase, 60 Hz
Voltage Range		187 - 253 V
MCA		16.0 A
MOCP/Breaker Size		25 A
Main Power Wire Size		12-2 AWG



Features & Function Summary

SYSTEM FEATURES	
Inverter Type	G10
Ultra Low Frequency Torque Control	Yes
Power Factor Correction	Yes
Compressor Type	High Eff. Rotary
Refrigerant Type	R410A
Basepan With Electric Heater	YES
Compressor With Electric Heater	YES
Outdoor Fin Coating	Blue Fin
Intelligent Defrosting	YES
Intelligent Preheating	YES
Low Voltage Startup	YES
Memory/Power Failure Recovery	YES
Self Diagnosis	YES
Wired Controller Interface (XK-41)	YES
Wi-Fi Interface Capable	Optional (see PN: WSBEC01)
Indoor Fan Type	Crossflow
Multi Fan Speeds	4 Speeds
Indoor Unit Display	YES
Advance Filter	Optional (see Filter Kits)
Auxiliary Electrical Heater	NO
Ventilation (Outdoor Air)	NO

REMOTE CONTROLLER FUNCTIONS	
Auto Mode	YES
Auto Fan	YES
Auto Swing (Horizontal Auto Swing)	NO
Auto Swing (Vertical Auto Swing)	YES
Clock on Remote Controller	YES
Dry Mode	YES
Dry Anti-Mildew (X-Fan) Mode	NO
Energy Saving Mode	YES
Dirty Filter Alert	NO
I Feel Function	YES
Lock on Remote Controller	YES
Quiet Mode	NO
Room Temperature Display	YES
Sleep Mode	YES
4 Sleep Modes Options	NO
Timer Mode	YES
Turbo Mode	YES
Display On/Off Control	YES
Freeze Guard Mode	YES
Display On/Off Control	YES
Freeze Guard Mode	YES

EXTENDED RATINGS

COOLING PERFORMANCE (BtuH)*

Outdoor Ambient DB	Indoor Ambient Temperature							
	68F DB (20C)		73F DB (23C)		80F DB (27C)		82F DB (28C)	
	57F WB (14C)		61F WB (16C)		67F WB (19C)		68F WB (20C)	
	TC	SHC	TC	SHC	TC	SHC	TC	SHC
0°F	9,302	7,296	9,827	7,704	11,091	8,699	11,423	8,910
5°F	10,111	7,930	10,682	8,374	12,055	9,455	12,417	9,685
14°F	11,729	9,199	12,391	9,714	13,984	10,968	14,404	11,235
23°F	12,850	10,080	13,745	10,782	15,749	12,352	16,221	12,653
32°F	13,332	10,458	14,260	11,186	16,339	12,815	16,830	13,127
41°F	13,832	10,850	14,795	11,605	16,952	13,296	17,461	13,619
50°F	14,351	11,257	15,350	12,041	17,588	13,794	18,115	14,130
59°F	15,583	12,222	16,668	13,072	18,255	14,314	18,803	14,666
68°F	17,649	13,842	18,752	14,705	20,038	15,716	20,640	16,099
77°F	17,440	13,680	18,549	14,549	19,855	15,574	20,450	15,951
86°F	16,582	13,004	17,685	13,873	19,303	15,139	19,882	15,508
95°F	15,694	12,309	16,025	12,569	18,384	14,419	18,935	14,770
104°F	14,934	11,713	15,259	11,967	17,056	14,047	17,567	13,702
113°F	14,168	11,111	14,707	11,533	15,833	13,445	16,308	12,720
115°F	14,126	11,078	14,768	11,581	15,787	13,393	16,261	12,683

HEATING PERFORMANCE (BtuH)*

Outdoor Ambient DB	Indoor Ambient Temperature							
	68F DB (20C)		73F DB (23C)		80F DB (27C)		86F DB (30C)	
	57F WB (14C)		61F WB (16C)		67F WB (19C)		72F WB (22C)	
	TC	SHC	TC	SHC	TC	SHC	TC	SHC
-4°F	10,146	10,146	9,975	9,975	9,776	9,776	9,572	9,572
0°F	10,994	10,994	10,811	10,811	10,596	10,596	10,365	10,365
6°F	11,598	11,598	11,402	11,402	11,176	11,176	10,933	10,933
10°F	12,080	12,080	11,878	11,878	11,642	11,642	11,390	11,390
16°F	12,446	12,446	12,238	12,238	11,995	11,995	11,732	11,732
19°F	12,684	12,684	12,476	12,476	12,228	12,228	11,958	11,958
24°F	14,111	14,111	13,898	13,898	13,621	13,621	13,385	13,385
32°F	15,771	15,771	15,557	15,557	15,248	15,248	15,045	15,045
41°F	17,668	17,668	17,461	17,461	17,113	17,113	16,942	16,942
43°F	18,144	18,144	17,930	17,930	17,574	17,574	17,418	17,418
47°F	19,718	19,718	19,376	19,376	18,991	18,991	18,534	18,534
53°F	19,913	19,913	19,565	19,565	19,176	19,176	18,717	18,717
59°F	20,371	20,371	20,011	20,011	19,613	19,613	19,144	19,144
64°F	20,804	20,804	20,438	20,438	20,031	20,031	19,553	19,553
70°F	21,194	21,194	20,828	20,828	20,414	20,414	19,925	19,925
75°F	21,493	21,493	21,115	21,115	20,695	20,695	20,200	20,200

* Maximum system capacity

TC- Total Capacity (BtuH)
 SHC- Sensible Capacity (BtuH)

DIMENSIONAL SPECIFICATIONS

MINIMUM SPACING REQUIREMENTS

Units: inch (mm)

INDOOR

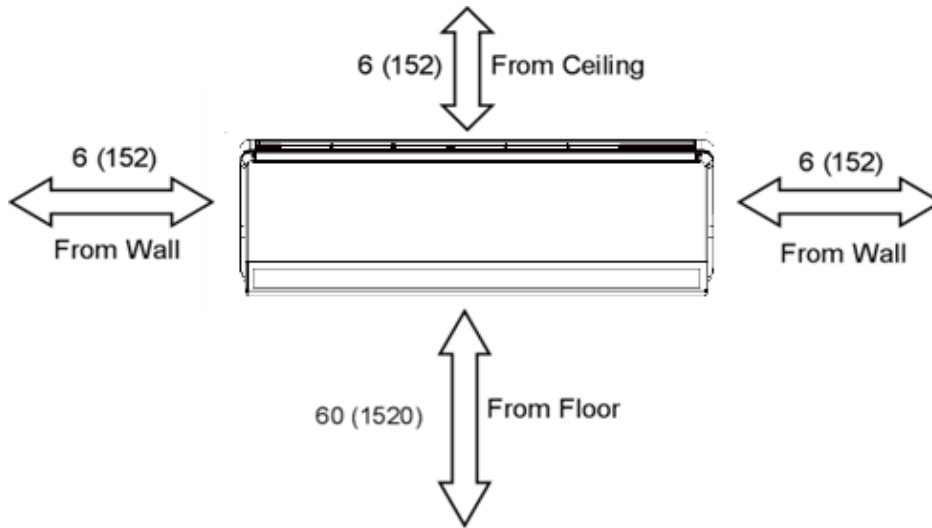

Units: inch (mm)

OUTDOOR

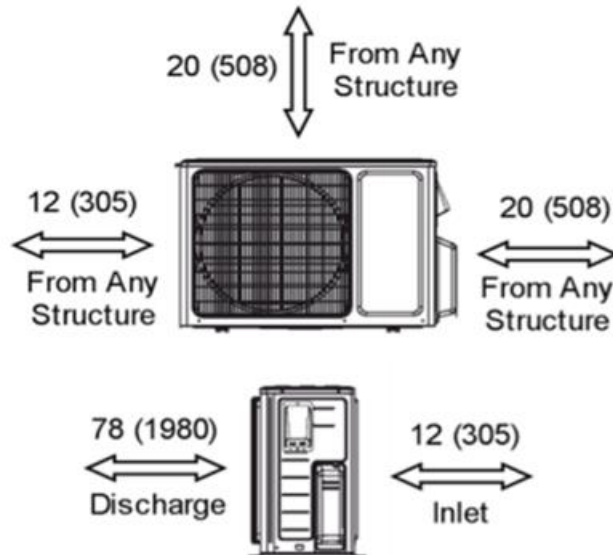

DIMENSIONAL SPECIFICATIONS

INDOOR UNIT DIMENSIONS

Units: inch

Model No: LIVS18HP230V1BH

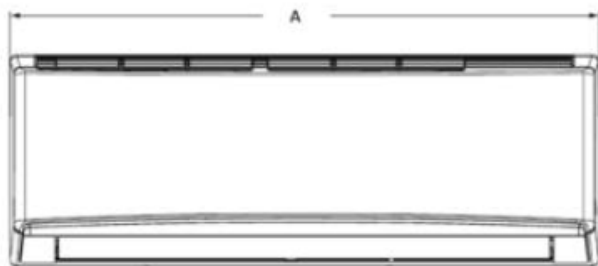

Dimensions	
A	38.2
B	11.8
C	8.8

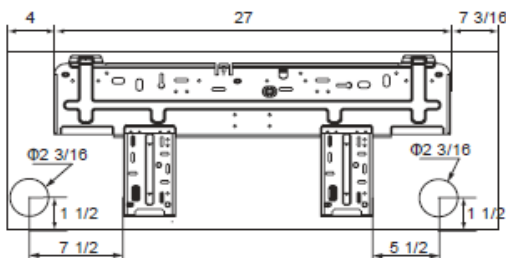

Weight (Net/Gross) 29.8/36.4 lbs

Liquid Line Valve	1/4-in OD Flared
Gas Line Valve	1/2-in OD Flared
Drain Connector	5/8-in OD

OUTDOOR UNIT DIMENSIONS

Units: inch

Model No: LIVS18HP230V1BO

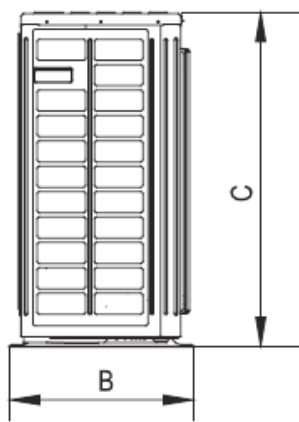
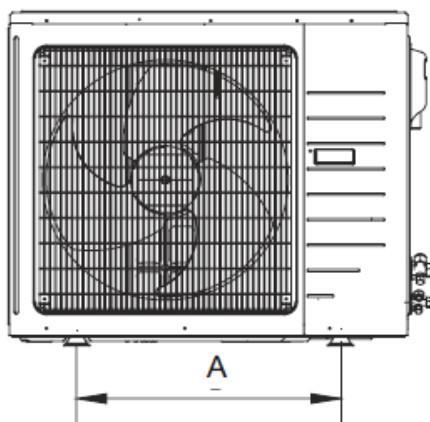

Dimensions	
A	22.0
B	15.3
C	27.6
D	38.0
E	14.3

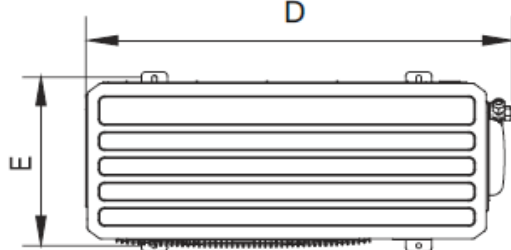

Weight (Net/Gross) 95.9/105.8 lbs

Liquid Line Valve	1/4-in OD Flared
Gas Line Valve	1/2-in OD Flared

Notes:

1. Recommended Interconnecting Cable Type 14 AWG 4 Stranded Copper Conductors THHN 600V Wire
2. Power wiring cable size must comply with applicable national and local codes.
3. Test conditions are based on AHRI 210/240.