

Submittal Data: LIVS30HP230V1B 30,000 BTU/H (208/230V) Wall Mounted Heat Pump System

Job Name _____ Location _____ Date _____

Purchaser _____ Engineer _____

Submitted To _____ For Reference Approval Construction

Unit Designation _____ Schedule No. _____

GENERAL FEATURES
 -High Efficiency DC Inverter Technology
 -Compact and Quiet Design
 -Vertical Swing Louver
 -Wireless Remote with LCD Display
 -Wired Prog. Controller (Sold Separately)
 -Low Ambient Cool to 0 deg F
 -Blue Fin Condenser Coil
 -5 year Limited Parts Warranty, 7 year Limited Compressor Warranty

System Ratings

Cooling		
Rated Capacity		28,000 BTU/H
Capacity Range		9,500-30,000 BTU/H
Power Input (Max)		2,700 W
SEER		16.0
EER		9.3
Heating at 47° F		
Rated Capacity		28,400 BTU/H
Capacity Range		10,000-33,000 BTU/H
Power Input (Max)		2,800 W
HSPF		8.2
COP		3.0
Heating at 17° F		
Rated Capacity		18,400 BTU/H
Operating Range		
Cooling	(Max)	109°F (43 C)
	(Min)	0°F (-18 C)
Heating	(Max)	75°F (24 C)
	(Min)	-4°F (-20 C)

Refrigerant Piping Data

Gas Pipe Size (OD)	5/8-in
Liquid Pipe Size (OD)	1/4-in
Connection Method	Flared
Factory Charge	84.7 oz
Additional Charge	0.54 oz/ft
Pre-Charge Length	25-ft
MAX Refrigerant Pipe Length	98-ft
MIN Refrigerant Pipe Length	10-ft
MAX Refrigerant Pipe Elevation	33-ft

Indoor Unit Data

Fan Motor	Type	Cross-Flow
	Output Power	70 W
	FLA	0.4 A
Airflow		
Cooling	Wet (Lo/Hi)	412/706 CFM
Heating	Dry (Lo/Hi)	412/706 CFM
Sound Pressure Level		
Cooling	(Min/Max)	41/56 db(A)
Heating	(Min/Max)	41/56 db(A)
Dehumidification		6.34 pt/hr

Outdoor Unit Data

Compressor	Type	DC Inverter Driven Rotary
	RLA	13.5 A
Refrigerant Type		R410A
Fan Motor	Output Power	120 W
	FLA	0.45 A

Sound Pressure	Cooling/Heating	62/62 db(A)
-----------------------	-----------------	-------------

Electrical Data

Power Supply		
Normal Operational Voltage		208/230 V, 1 Phase, 60 Hz
Voltage Range		187 - 253 V
MCA		20.0 A
MOCP/Breaker Size		30 A
Main Power Wire Size		10-2 AWG



Features & Function Summary

SYSTEM FEATURES	
Inverter Type	G10
Ultra Low Frequency Torque Control	Yes
Power Factor Correction	Yes
Compressor Type	High Eff. Rotary
Refrigerant Type	R410A
Basepan With Electric Heater	YES
Compressor With Electric Heater	YES
Outdoor Fin Coating	Blue Fin
Intelligent Defrosting	YES
Intelligent Preheating	YES
Low Voltage Startup	YES
Memory/Power Failure Recovery	YES
Self Diagnosis	YES
Wired Controller Interface (XK-41)	YES
Wi-Fi Interface Capable	NO
Indoor Fan Type	Crossflow
Multi Fan Speeds	4 Speeds
Indoor Unit Display	YES
Advance Filter	Optional (see Filter Kits)
Auxiliary Electrical Heater	NO
Ventilation (Outdoor Air)	NO

REMOTE CONTROLLER FUNCTIONS	
Auto Mode	YES
Auto Fan	YES
Auto Swing (Horizontal Auto Swing)	NO
Auto Swing (Vertical Auto Swing)	YES
Clock on Remote Controller	YES
Dry Mode	YES
Dry Anti-Mildew (X-Fan) Mode	NO
Energy Saving Mode	YES
Dirty Filter Alert	NO
I Feel Function	YES
Lock on Remote Controller	YES
Quiet Mode	NO
Room Temperature Display	YES
Sleep Mode	YES
4 Sleep Modes Options	NO
Timer Mode	YES
Turbo Mode	YES
Display On/Off Control	YES
Freeze Guard Mode	YES
Display On/Off Control	YES
Freeze Guard Mode	YES

EXTENDED RATINGS

COOLING PERFORMANCE (BtuH)*

Outdoor Ambient DB	Indoor Ambient Temperature							
	68F DB (20C)		73F DB (23C)		80F DB (27C)		82F DB (28C)	
	57F WB (14C)		61F WB (16C)		67F WB (19C)		68F WB (20C)	
	TC	SHC	TC	SHC	TC	SHC	TC	SHC
0°F	15,794	12,387	16,686	13,081	18,831	14,770	19,114	14,991
5°F	16,626	13,039	17,564	13,770	19,822	15,547	20,120	15,780
14°F	18,288	14,343	19,320	15,147	21,805	17,102	22,132	17,358
23°F	20,037	15,718	21,432	16,811	24,556	19,260	25,047	19,549
32°F	20,838	16,346	22,289	17,484	25,539	20,030	26,049	20,331
41°F	21,672	17,000	23,181	18,183	26,560	20,832	27,091	21,144
50°F	22,539	17,680	24,108	18,910	27,623	21,665	28,175	21,990
59°F	24,298	19,057	25,990	20,383	28,464	22,318	29,034	22,653
68°F	27,518	21,583	29,238	22,928	31,245	24,506	31,870	24,873
77°F	27,194	21,331	28,923	22,686	30,958	24,283	31,577	24,647
86°F	25,856	20,276	27,576	21,631	30,098	23,606	30,700	23,960
95°F	24,470	19,192	26,181	20,528	28,665	22,483	29,238	22,820
104°F	23,286	18,263	24,986	19,599	27,920	21,902	28,478	22,231
113°F	22,091	17,324	23,792	18,660	26,735	20,963	27,270	21,278
115°F	21,954	17,217	23,620	18,525	26,545	20,815	27,076	21,128

HEATING PERFORMANCE (BtuH)*

Outdoor Ambient DB	Indoor Ambient Temperature							
	68F DB (20C)		73F DB (23C)		80F DB (27C)		86F DB (30C)	
	57F WB (14C)		61F WB (16C)		67F WB (19C)		72F WB (22C)	
	TC	SHC	TC	SHC	TC	SHC	TC	SHC
-4°F	15,986	15,986	15,717	15,717	15,259	15,259	15,083	15,083
0°F	17,322	17,322	17,034	17,034	17,178	17,178	16,332	16,332
6°F	18,274	18,274	17,966	17,966	18,126	18,126	17,226	17,226
10°F	19,033	19,033	18,716	18,716	18,878	18,878	17,947	17,947
16°F	19,610	19,610	19,283	19,283	19,441	19,441	18,485	18,485
19°F	19,985	19,985	19,658	19,658	19,816	19,816	18,841	18,841
24°F	22,234	22,234	21,898	21,898	22,129	22,129	21,091	21,091
32°F	24,849	24,849	24,513	24,513	24,817	24,817	23,705	23,705
41°F	27,839	27,839	27,512	27,512	27,891	27,891	26,695	26,695
43°F	28,589	28,589	28,252	28,252	28,662	28,662	27,445	27,445
47°F	31,069	31,069	30,530	30,530	30,757	30,757	29,204	29,204
53°F	31,376	31,376	30,828	30,828	31,064	31,064	29,492	29,492
59°F	32,097	32,097	31,530	31,530	31,766	31,766	30,165	30,165
64°F	32,780	32,780	32,203	32,203	32,448	32,448	30,809	30,809
70°F	33,395	33,395	32,818	32,818	33,060	33,060	31,395	31,395
75°F	33,866	33,866	33,270	33,270	33,525	33,525	31,828	31,828

* Maximum system capacity

TC- Total Capacity (BtuH)
SHC- Sensible Capacity (BtuH)

DIMENSIONAL SPECIFICATIONS

MINIMUM SPACING REQUIREMENTS

Units: inch (mm)

INDOOR

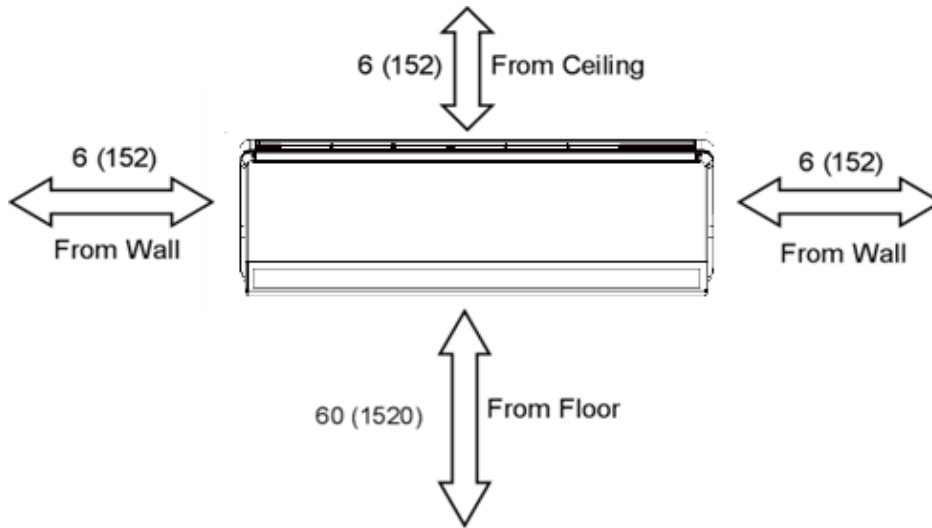

Units: inch (mm)

OUTDOOR

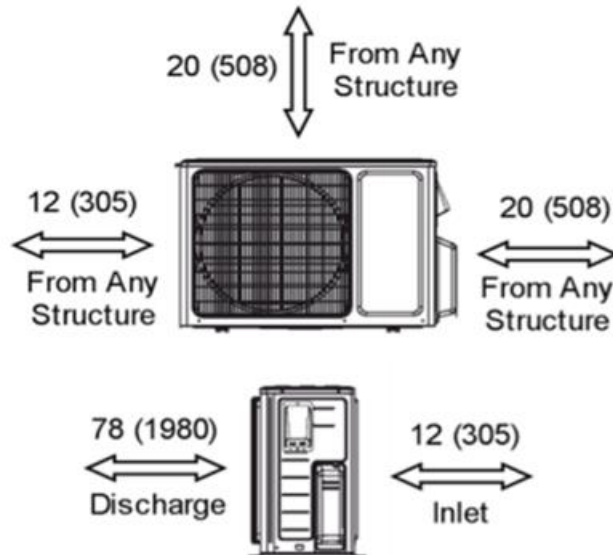

DIMENSIONAL SPECIFICATIONS

INDOOR UNIT DIMENSIONS

Units: inch

Model No: LIVS30HP230V1BH

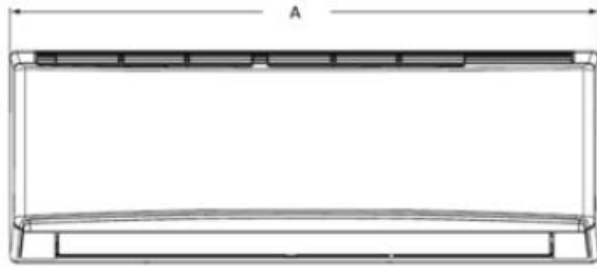

Dimensions	
A	53.2
B	12.8
C	10.0

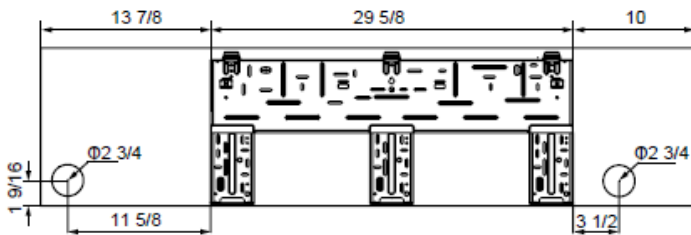

Weight (Net/Gross) 41.9/57.3 lbs

Liquid Line Valve	1/4-in OD Flared
Gas Line Valve	5/8-in OD Flared
Drain Connector	5/8-in OD

OUTDOOR UNIT DIMENSIONS

Units: inch

Model No: LIVS30HP230V1BO

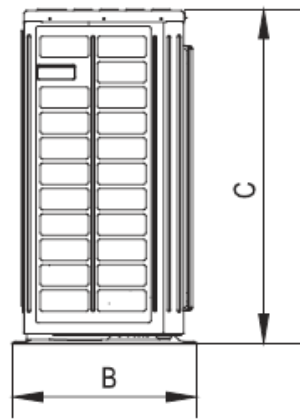
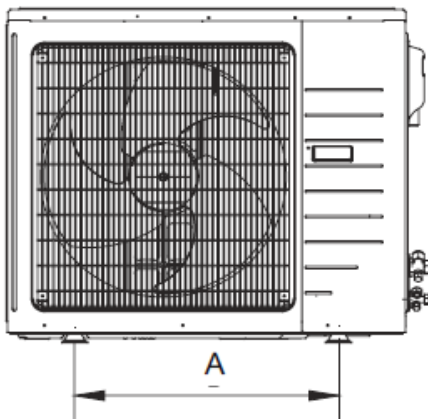

Dimensions	
A	24.0
B	16.8
C	31.2
D	39.4
E	15.6

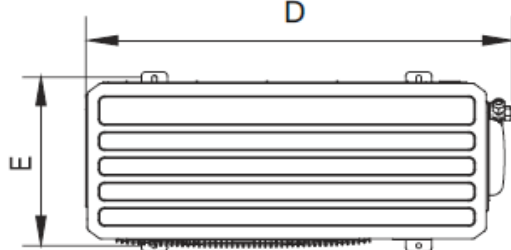

Weight (Net/Gross) 154.4/163.2 lbs

Liquid Line Valve	1/4-in OD Flared
Gas Line Valve	5/8-in OD Flared

Notes:

1. Recommended Interconnecting Cable Type 14 AWG 4 Stranded Copper Conductors THHN 600V Wire
2. Power wiring cable size must comply with applicable national and local codes.
3. Test conditions are based on AHRI 210/240.