

**Submittal Data: TW36HQ3B2D** 36,000 BTU/H Wall Mounted Heat- Pump System

Job Name \_\_\_\_\_ Location \_\_\_\_\_ Date \_\_\_\_\_

Purchaser \_\_\_\_\_ Engineer \_\_\_\_\_

Submitted To \_\_\_\_\_ For  Reference  Approval  Construction

Unit Designation \_\_\_\_\_ Schedule No. \_\_\_\_\_

- GENERAL FEATURES**
- Variable Speed (Inverter) Two-Stage/3 Cylinder Compressor
  - Ultra Heating ( down to -31° F)
  - Ultra Cooling ( 0°F to 115° F)
  - WiFi Controls -Optional
  - 4 Indoor Fan Speeds
  - 2 Way Airflow Operation
  - Wireless Remote with LCD Display
  - Copper Tube/Aluminum Fins w/ Acrylic Resin Anti-Corrosion
  - Energy Saving Mode
  - 5 year Limited Parts Warranty

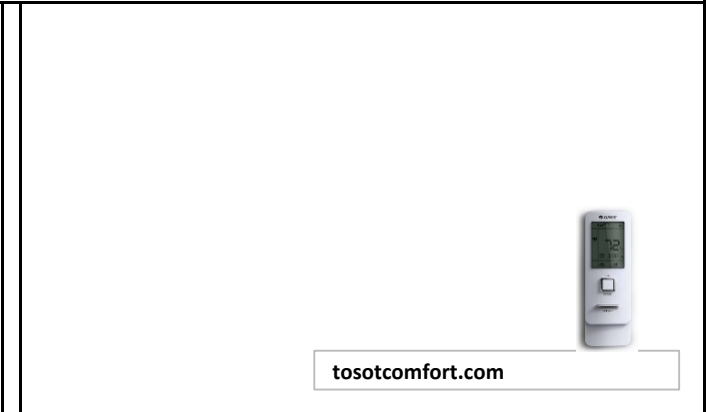

**System Ratings**

**Indoor Unit Data**

<b>Cooling</b>	
Rated Capacity	33,000 BTU/H
Capacity Range	8,800 -40,900 BTU/H
Power Input (Max)	4,100 W
SEER	23.0
EER	10.25

<b>Fan Motor</b>	Type	Cross-flow
	Output Power	70 W
	RLA	0.4 A
<b>Airflow</b>	(Low/High) Cooling	441/824 CFM
	(Low/High) Heating	441/824 CFM
<b>Air Throw</b>	(Max)	31 ft
<b>Sound Pressure Level</b>		
	Cooling (/High - Low)	65/60/56/47 dB(A)
	Heating (/High - Low)	65/60/56/47 dB(A)
<b>Dehumidification</b>		7.4 pt/hr

<b>Heating at 47° F</b>	
Rated Capacity	34,600 BTU/H
Capacity Range	4,900 -49,400 BTU/H
Power Input (Max)	7,100 W
HSPF	10.5
COP	3.17

**Outdoor Unit Data**

<b>Heating at 17° F</b>	
Rated Capacity	34,600 BTU/H

<b>Compressor</b>	Type	DC Inverter Driven 2-Stage Rotary
	RLA	24 A
<b>Fan Motor</b>	Output Power	170 W
	RLA	0.73 A
<b>Sound Pressure Level</b>		63 dB(A)

<b>Operating Range</b>			
Cooling	(Max)	115°F (46°C)	
	(Min)	0°F (-18°C)	
Heating	(Max)	75°F (24°C)	
	(Min)	-31°F (-35°C)	

**Refrigerant Piping Data**

<b>Power Supply</b>	
Normal Operational Voltage	208/230 V, 1 Phase, 60 Hz
Voltage Range	187 - 253 V
Main Power Wire Size	8-2 AWG
Interconnecting Cable Wire Size	14-4 AWG
MCA	32 A
MOCP/Breaker Size	50 A

Gas Pipe Size (OD)	5/8-in
Liquid Pipe Size (OD)	1/4-in
Connection Method	Flared
Factory Charge R410A	123.5 oz
Additional Charge	0.30 oz/ft
Pre-Charge Length	25-ft
MAX Refrigerant Pipe Length	165-ft
MIN Refrigerant Pipe Length	10-ft
MAX Refrigerant Pipe Elevation	100-ft

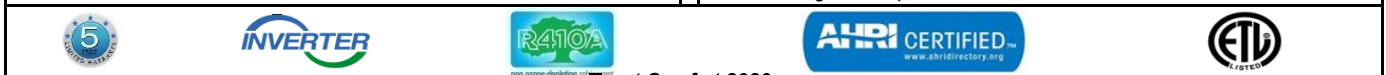

<b>SYSTEM FEATURES</b>	
Inverter Type	G10
Ultra Low Frequency Torque Control	Yes
Power Factor Correction	Yes
Compressor Type	High Eff. Two Stage Rotary
Refrigerant Type	R410A
Basepan With Electric Heater	YES
Compressor With Electric Heater	YES
Indoor & Outdoor Fin Coating	Acrylic Resin/Anti-Corrosion
Intelligent Defrosting	YES
Intelligent Preheating	YES
Low Voltage Startup	YES
Memory/Power Failure Recovery	YES
Self Diagnosis	YES
Wired Controller Interface	YES
Wi-Fi Interface - Standard	YES
Indoor Fan Type	Cross-flow
Multi Fan Speeds	4 Speeds
Indoor Unit Display	YES
Indoor Air Quality Filters	Optional
Auxiliary Electrical Heater	NO
Ventilation (Outdoor Air)	NO

<b>REMOTE CONTROLLER FUNCTIONS</b>	
Auto Mode	YES
Auto Fan	YES
Auto Swing (Horizontal Auto Swing)	NO
Auto Swing (Vertical Auto Swing)	YES
Clock on Remote Controller	YES
Dry Mode	YES
Dry Anti-Mildew (X-Fan) Mode	YES
Energy Saving Mode	YES
Dirty Filter Alert	NO
I Feel Function	NO
Lock on Remote Controller	YES
Quiet Mode	NO
Room Temperature Display	NO
Sleep Mode	YES
4 Sleep Modes Options	YES
Timer Mode	YES
Turbo Mode	YES
Display On/Off Control	YES
Freeze Guard Mode	NO
Display On/Off Control	YES

**EXTENDED RATINGS****TW36HQ3B2D****ULTRA COOL****COOLING PERFORMANCE (BtuH)\***

Outdoor Ambient Temperature (DB) °F	Indoor Entering Air Temperatures					
	68F DB		73°F DB		80°F DB	
	57F WB		61°FWB		67°FWB	
	TC	SHC	TC	SHC	TC	SHC
0°F	11220	8135	13860	10049	16500	11963
5°F	12870	9395	15510	11322	18150	13250
14°F	14520	10672	17160	12613	19800	14553
23°F	15180	11233	17820	13187	20460	15140
32°F	15840	11801	18480	13768	21120	15734
41°F	17820	13365	20460	15345	23100	17325
50°F	19800	14949	22440	16942	25080	18935
59°F	21120	16051	23760	18058	26400	20064
68°F	22110	16914	24750	18934	27390	20953
77°F	27720	21344	30360	23377	33000	25410
86°F	30690	23785	33330	25831	35970	27877
95°F	27720	21622	30360	23681	33000	25740
104°F	26070	20465	28710	22537	31350	24610
113°F	22770	17988	25410	20074	28050	22160

**ULTRA HEAT****HEATING PERFORMANCE (BtuH)\***

Outdoor Ambient Temperature (DB)	Indoor Entering Air Temperatures		
	68°F DB	73°F DB	80°F DB
	57°FWB	61°FWB	67°FWB
	TC	TC	TC
-31°F	21279	20760	20241
-22°F	24739	24220	23701
-13°F	28199	27680	27161
-4°F	31659	31140	30621
0°F	33389	32870	32351
6°F	35119	34600	34081
10°F	35119	34600	34081
17°F	35119	34600	34081
19°F	35119	34600	34081
24°F	35119	34600	34081
32°F	35119	34600	34081
41°F	35119	34600	34081
43°F	35811	35292	34773
47°F	35036	34600	34303
53°F	33864	33429	33131
59°F	32842	32435	32181
64°F	31229	30938	30496
70°F	29442	29093	28767
75°F	27708	27344	27047
78°F	26908	26282	25846

\* Maximum system capacity

TC- Total Capacity ( BtuH)

SHC- Sensible Capacity (BtuH)

MINIMUM SPACING REQUIREMENTS

Units: inch (mm)

INDOOR

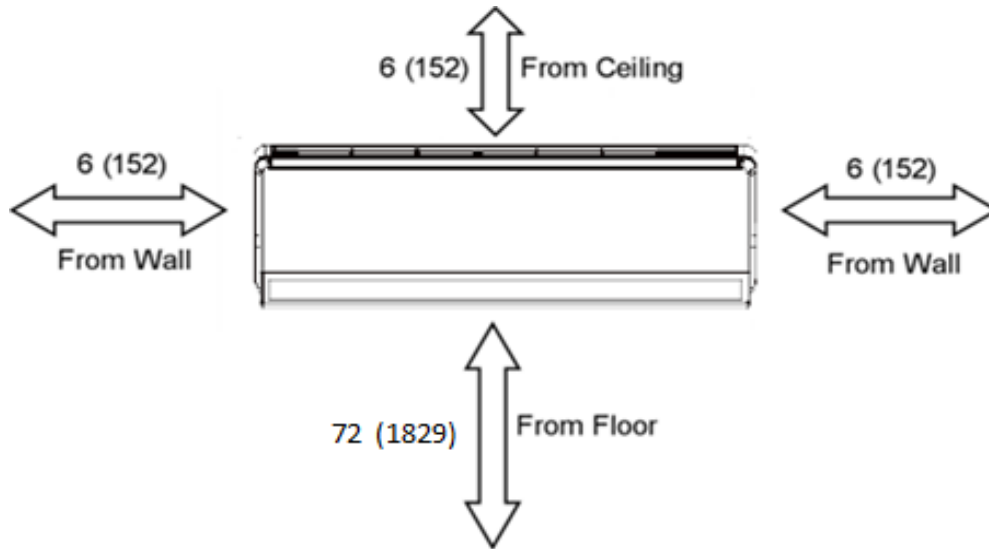

INSTALLATION SPECIFICATIONS

MINIMUM SPACING REQUIREMENTS

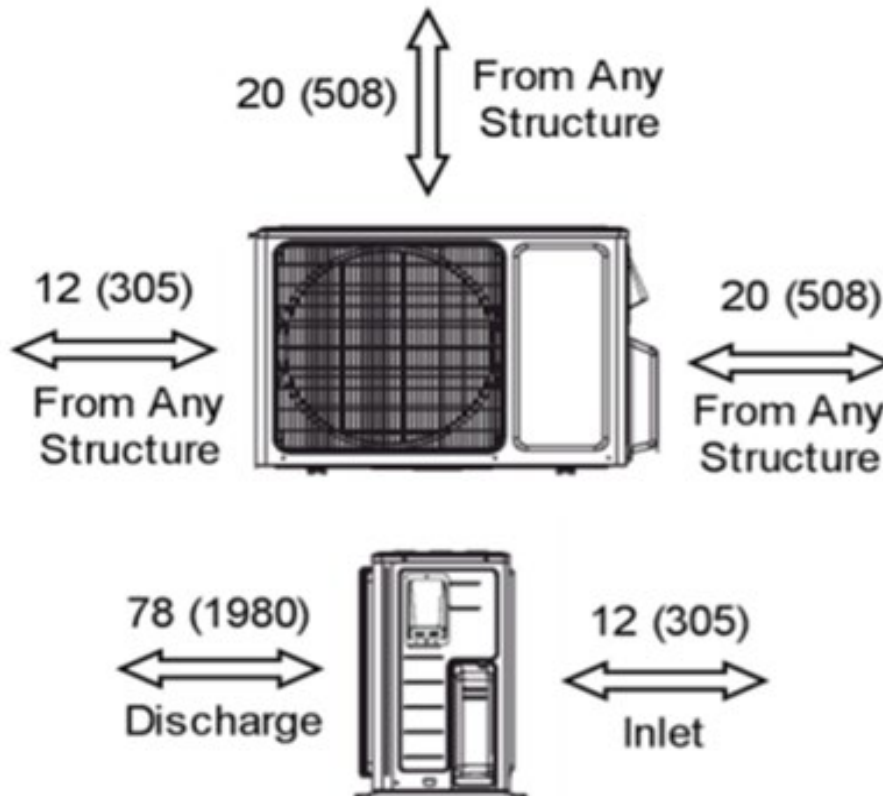

## DIMENSIONAL SPECIFICATIONS

## TW36HQ3B2D

### INDOOR UNIT DIMENSIONS

Units: inch

Model No: TW36HQ3B2DI

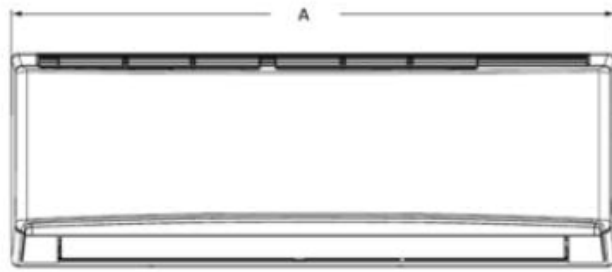

Dimensions	
A	53.1
B	12.8
C	10.0

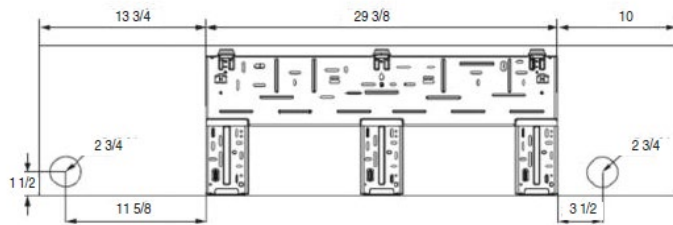

Weight (Net/Gross) 41.9/51.8 lbs

Liquid Line Valve	1/4-in OD Flared
Gas Line Valve	5/8-in OD Flared
Drain Connector	5/8-in OD

### OUTDOOR UNIT DIMENSIONS

Units: inch

Model No: TW36HQ3B2DO

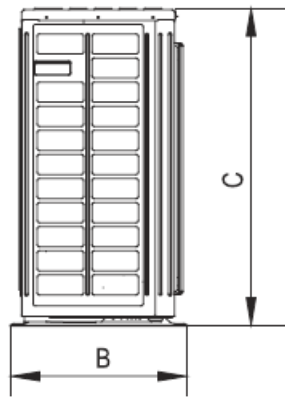
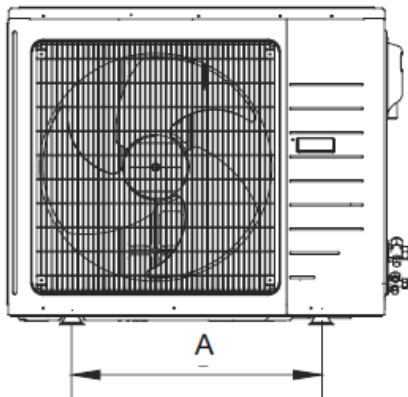

Dimensions	
A	23.2
B	17.3
C	43.5
D	43.5
E	15.8

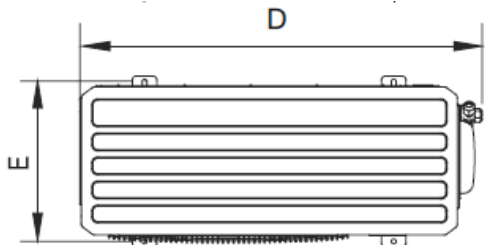

Weight (Net/Gross) 253.6/264.6 lbs

Liquid Line Valve	1/4-in OD Flared
Gas Line Valve	5/8-in OD Flared

**Notes:**

1. Recommended Interconnecting Cable Type 14 AWG-4 Stranded Copper Conductors THHN 600V Wire
2. Power wiring cable size must comply with applicable national and local codes.
3. Test conditions are based on AHRI 210/240.

Specifications are subject to change without notice. Manufacturer reserves the right to discontinue or modify specifications or designs without notice or without incurring obligations. All rights reserved.