

EXTENDED RATINGS

COOLING PERFORMANCE (BtuH)*

Outdoor Ambient DB	Indoor Ambient Temperature							
	68F DB (20C)		73F DB (23C)		80F DB (27C)		82F DB (28C)	
	57F WB (14C)		61F WB (16C)		67F WB (19C)		68F WB (20C)	
	TC	SHC	TC	SHC	TC	SHC	TC	SHC
5°F	7,656	6,005	8,088	6,341	9,128	7,159	9,508	7,458
14°F	7,852	6,159	8,292	6,503	9,476	7,431	9,871	7,740
23°F	8,388	6,580	8,972	7,038	10,280	8,063	10,708	8,399
32°F	10,172	7,978	10,880	8,533	11,916	9,343	12,413	9,732
41°F	11,520	9,035	12,240	9,598	13,080	10,259	13,625	10,686
50°F	11,384	8,930	12,108	9,497	12,960	10,166	13,500	10,589
59°F	11,104	8,707	11,824	9,274	12,840	10,072	13,375	10,492
68°F	10,824	8,488	11,544	9,055	12,600	9,882	13,125	10,294
77°F	10,548	8,273	11,264	8,833	12,360	9,696	12,875	10,100
86°F	10,244	8,034	10,960	8,594	12,000	9,412	12,500	9,804
95°F	9,996	7,840	10,708	8,399	11,844	9,290	12,338	9,678
104°F	9,748	7,645	10,460	8,205	11,688	9,169	12,175	9,551
113°F	9,248	7,252	9,960	7,812	11,192	8,776	11,658	9,142

HEATING PERFORMANCE (BtuH)*

Outdoor Ambient DB	Indoor Ambient Temperature							
	68F DB (20C)		73F DB (23C)		80F DB (27C)		86F DB (30C)	
	57F WB (14C)		61F WB (16C)		67F WB (19C)		72F WB (22C)	
	TC	SHC	TC	SHC	TC	SHC	TC	SHC
-4°F	6,401	6,401	6,340	6,340	6,233	6,233	5,982	5,982
0°F	6,935	6,935	6,870	6,870	6,756	6,756	6,477	6,477
6°F	7,316	7,316	7,248	7,248	7,126	7,126	6,832	6,832
10°F	7,621	7,621	7,549	7,549	7,423	7,423	7,118	7,118
16°F	7,850	7,850	7,778	7,778	7,648	7,648	7,331	7,331
19°F	8,006	8,006	7,926	7,926	7,797	7,797	7,473	7,473
24°F	8,895	8,895	8,818	8,818	8,685	8,685	8,365	8,365
32°F	9,932	9,932	9,855	9,855	9,722	9,722	9,402	9,402
41°F	11,117	11,117	11,041	11,041	10,911	10,911	10,587	10,587
43°F	11,415	11,415	11,338	11,338	11,205	11,205	10,885	10,885
47°F	12,448	12,448	12,322	12,322	12,109	12,109	11,582	11,582
53°F	12,574	12,574	12,444	12,444	12,227	12,227	11,697	11,697
59°F	12,860	12,860	12,730	12,730	12,505	12,505	11,964	11,964
64°F	13,134	13,134	13,001	13,001	12,772	12,772	12,219	12,219
70°F	13,382	13,382	13,245	13,245	13,016	13,016	12,452	12,452
75°F	13,569	13,569	13,431	13,431	13,195	13,195	12,623	12,623

* Maximum system capacity

TC- Total Capacity (BtuH)

SHC- Sensible Capacity (BtuH)

DIMENSIONAL SPECIFICATIONS

MINIMUM SPACING REQUIREMENTS

Units: inch (mm)

INDOOR

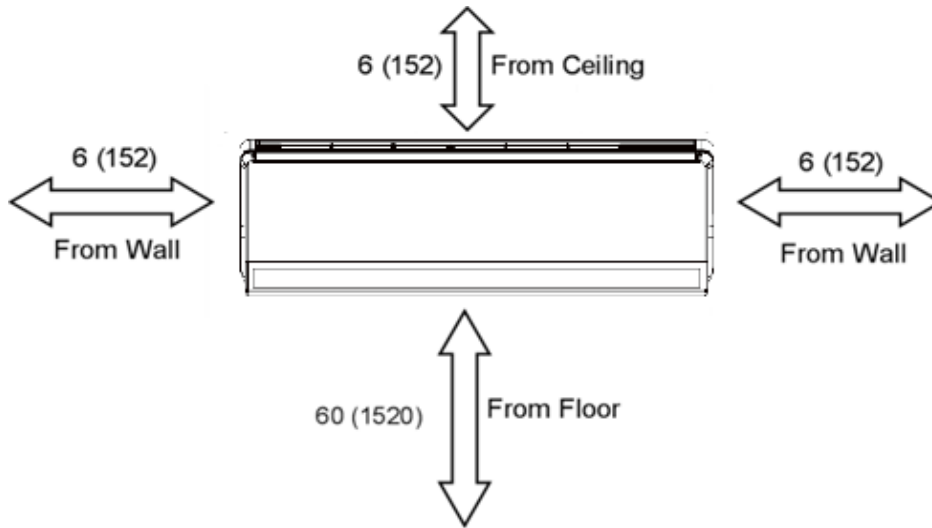

Units: inch (mm)

OUTDOOR

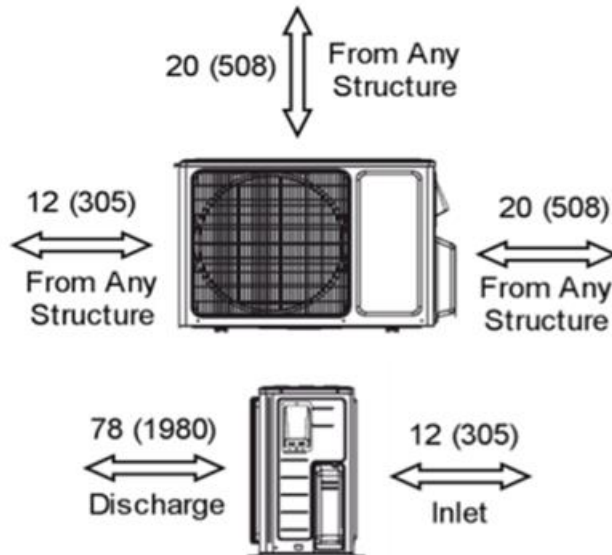

DIMENSIONAL SPECIFICATIONS

INDOOR UNIT DIMENSIONS

Units: inch

Model No: TW12HQ2C2AI

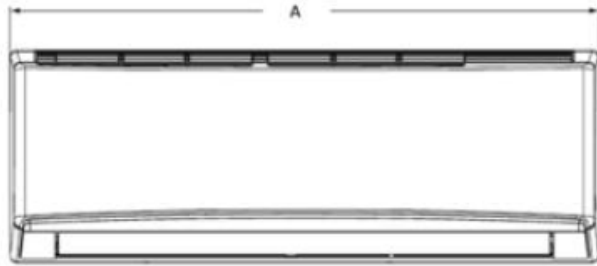

Dimensions	
A	33.4
B	11.4
C	8.2

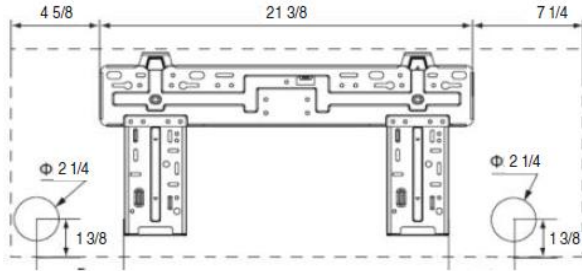

Weight (Net/Gross) 23.2/27.6 lbs

Liquid Line Valve	1/4-in OD Flared
Gas Line Valve	1/2-in OD Flared
Drain Connector	5/8-in OD

OUTDOOR UNIT DIMENSIONS

Units: inch

Model No: TW12HQ2C2AO

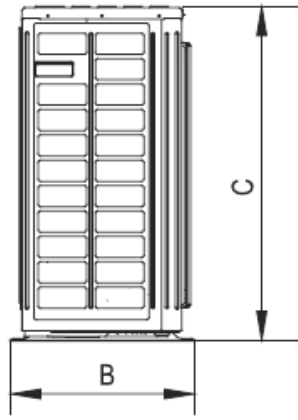
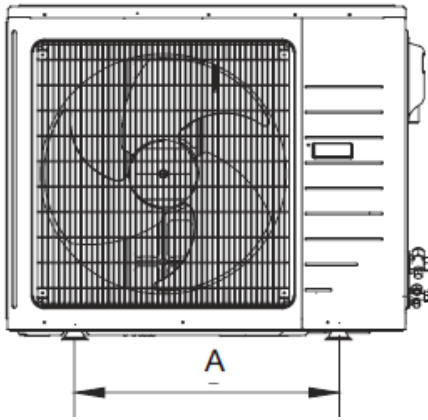

Dimensions	
A	21.3
B	12.6
C	21.3
D	33.4
E	11.3

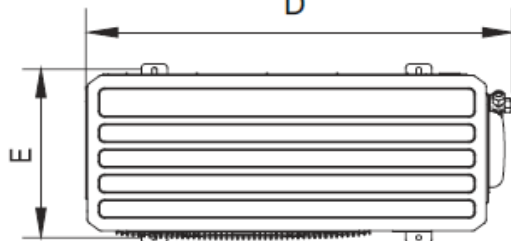

Weight (Net/Gross) 77.2/83.8 lbs

Liquid Line Valve	1/4-in OD Flared
Gas Line Valve	1/2-in OD Flared

Notes:

1. Recommended Interconnecting Cable Type 14 AWG-4 Stranded Copper Conductors THHN 600V Wire
2. Power wiring cable size must comply with applicable national and local codes.
3. Test conditions are based on AHRI 210/240.