

# TQSDT

**Submittal Data: LIVS24HP230V1B** 24,000 BTU/H (208/230V) Wall Mounted Heat Pump System

Job Name Location Date

Purchaser Engineer

Submitted To For  Reference  Approval  Construction

Unit Designation Schedule No.

**GENERAL FEATURES**

- High Efficiency DC Inverter Technology
- Compact and Quiet Design
- Wireless Remote with LCD Display
- Wi-Fi Ready ( Sold Separately Kit PN: WSBE02)
- XK41 Wired Prog. Controller ( Sold Separately)
- Low Ambient Cool to 0 deg F
- Blue Fin Condenser Coil
- 5 year Limited Parts Warranty, 7 year Limited Parts Warranty

**System Ratings Indoor Unit Data**

System Ratings			Indoor Unit Data		
<b>Cooling</b>			<b>Fan Motor</b>	Type	Cross-Flow
Rated Capacity		22,000 BTU/H		Output Power	40 W
Capacity Range		8,630-23,200 BTU/H		FLA	0.3 A
Power Input (Max)		2,260 W	<b>Airflow</b>		
SEER		16.0	Cooling Wet (Lo/Hi)		530/706 CFM
EER		9.75	Heating Dry (Lo/Hi)		530/706 CFM
<b>Heating at 47° F</b>			<b>Sound Pressure Level</b>		
Rated Capacity		23,000 BTU/H	Cooling (Min/Max)		36/48 db(A)
Capacity Range		8,650-26,000 BTU/H	Heating (Min/Max)		36/48 db(A)
Power Input (Max)		2,300 W	<b>Dehumidification</b>		5.28 pt/hr
HSPF		9.0			
COP		2.9			
<b>Heating at 17° F</b>					
Rated Capacity		13,500 BTU/H			

**Outdoor Unit Data**

<b>Compressor</b>	Type	DC Inverter Driven Rotary
	RLA	12.2 A
<b>Refrigerant Type</b>		R410A
<b>Fan Motor</b>	Output Power	60 W
	FLA	0.40 A

**Refrigerant Piping Data**

Gas Pipe Size (OD)	5/8-in
Liquid Pipe Size (OD)	1/4-in
Connection Method	Flared
Factory Charge	65.3 oz
Additional Charge	0.54 oz/ft
Pre-Charge Length	25-ft
MAX Refrigerant Pipe Length	82-ft
MIN Refrigerant Pipe Length	10-ft
MAX Refrigerant Pipe Elevation	33-ft

**Electrical Data**

<b>Power Supply</b>	Normal Operational Voltage	208/230 V, 1 Phase, 60 Hz
	Voltage Range	187 - 253 V
	MCA	16.0 A
	MOCP/Breaker Size	25 A
	Main Power Wire Size	12-2 AWG



## Features & Function Summary

SYSTEM FEATURES	
Inverter Type	G10
Ultra Low Frequency Torque Control	Yes
Power Factor Correction	Yes
Compressor Type	High Eff. Rotary
Refrigerant Type	R410A
Basepan With Electric Heater	YES
Compressor With Electric Heater	YES
Outdoor Fin Coating	Blue Fin
Intelligent Defrosting	YES
Intelligent Preheating	YES
Low Voltage Startup	YES
Memory/Power Failure Recovery	YES
Self Diagnosis	YES
Wired Controller Interface (XK-41)	YES
Wi-Fi Interface Capable	Optional (see PN: WSBEC01)
Indoor Fan Type	Crossflow
Multi Fan Speeds	4 Speeds
Indoor Unit Display	YES
Advance Filter	Optional (see Filter Kits)
Auxiliary Electrical Heater	NO
Ventilation (Outdoor Air)	NO

REMOTE CONTROLLER FUNCTIONS	
Auto Mode	YES
Auto Fan	YES
Auto Swing (Horizontal Auto Swing)	NO
Auto Swing (Vertical Auto Swing)	YES
Clock on Remote Controller	YES
Dry Mode	YES
Dry Anti-Mildew (X-Fan) Mode	NO
Energy Saving Mode	YES
Dirty Filter Alert	NO
I Feel Function	YES
Lock on Remote Controller	YES
Quiet Mode	NO
Room Temperature Display	YES
Sleep Mode	YES
4 Sleep Modes Options	NO
Timer Mode	YES
Turbo Mode	YES
Display On/Off Control	YES
Freeze Guard Mode	YES
Display On/Off Control	YES
Freeze Guard Mode	YES

**EXTENDED RATINGS**

**COOLING PERFORMANCE (BtuH)\***

Outdoor Ambient DB	Indoor Ambient Temperature							
	68F DB (20C)		73F DB (23C)		80F DB (27C)		82F DB (28C)	
	57F WB (14C)		61F WB (16C)		67F WB (19C)		68F WB (20C)	
	TC	SHC	TC	SHC	TC	SHC	TC	SHC
0°F	10,940	8,580	11,557	9,061	13,043	10,230	13,434	10,479
5°F	11,891	9,326	12,562	9,848	14,177	11,120	14,603	11,390
14°F	13,794	10,818	14,572	11,424	16,446	12,899	16,939	13,212
23°F	15,112	11,855	16,165	12,680	18,521	14,526	19,077	14,880
32°F	15,679	12,299	16,771	13,155	19,216	15,071	19,792	15,438
41°F	16,267	12,761	17,400	13,648	19,936	15,636	20,534	16,017
50°F	16,877	13,239	18,052	14,160	20,684	16,223	21,304	16,617
59°F	18,327	14,373	19,602	15,373	21,469	16,833	22,113	17,248
68°F	20,755	16,278	22,052	17,293	23,566	18,483	24,273	18,933
77°F	20,510	16,089	21,815	17,111	23,350	18,315	24,050	18,759
86°F	19,501	15,293	20,798	16,315	22,701	17,804	23,382	18,238
95°F	18,456	14,475	18,845	14,782	21,620	16,957	22,269	17,370
104°F	17,563	13,775	17,945	14,074	20,058	16,519	20,660	16,115
113°F	16,662	13,067	17,296	13,563	18,621	15,811	19,179	14,960
115°F	16,612	13,028	17,368	13,620	18,566	15,750	19,123	14,916

**HEATING PERFORMANCE (BtuH)\***

Outdoor Ambient DB	Indoor Ambient Temperature							
	68F DB (20C)		73F DB (23C)		80F DB (27C)		86F DB (30C)	
	57F WB (14C)		61F WB (16C)		67F WB (19C)		72F WB (22C)	
	TC	SHC	TC	SHC	TC	SHC	TC	SHC
-4°F	11,659	11,659	11,463	11,463	11,235	11,235	11,000	11,000
0°F	12,634	12,634	12,423	12,423	12,176	12,176	11,912	11,912
6°F	13,328	13,328	13,103	13,103	12,843	12,843	12,564	12,564
10°F	13,882	13,882	13,650	13,650	13,379	13,379	13,089	13,089
16°F	14,302	14,302	14,064	14,064	13,784	13,784	13,482	13,482
19°F	14,576	14,576	14,337	14,337	14,052	14,052	13,741	13,741
24°F	16,216	16,216	15,971	15,971	15,653	15,653	15,382	15,382
32°F	18,123	18,123	17,878	17,878	17,522	17,522	17,289	17,289
41°F	20,304	20,304	20,065	20,065	19,666	19,666	19,469	19,469
43°F	20,851	20,851	20,605	20,605	20,195	20,195	20,016	20,016
47°F	22,659	22,659	22,267	22,267	21,824	21,824	21,299	21,299
53°F	22,884	22,884	22,484	22,484	22,037	22,037	21,510	21,510
59°F	23,410	23,410	22,996	22,996	22,538	22,538	22,000	22,000
64°F	23,907	23,907	23,487	23,487	23,019	23,019	22,470	22,470
70°F	24,356	24,356	23,935	23,935	23,459	23,459	22,898	22,898
75°F	24,700	24,700	24,265	24,265	23,782	23,782	23,213	23,213

\* Maximum system capacity

TC- Total Capacity ( BtuH)  
 SHC- Sensible Capacity (BtuH)

## DIMENSIONAL SPECIFICATIONS

### MINIMUM SPACING REQUIREMENTS

Units: inch (mm)

#### INDOOR

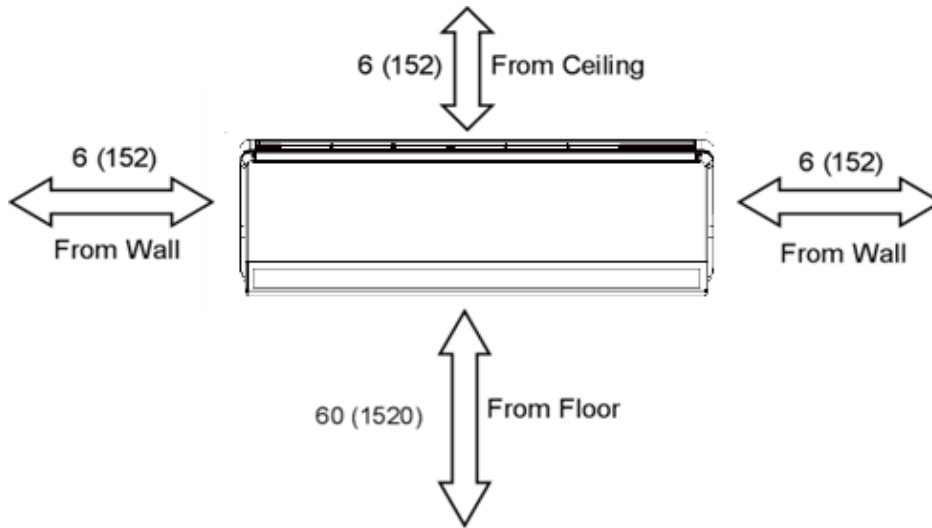

Units: inch (mm)

#### OUTDOOR

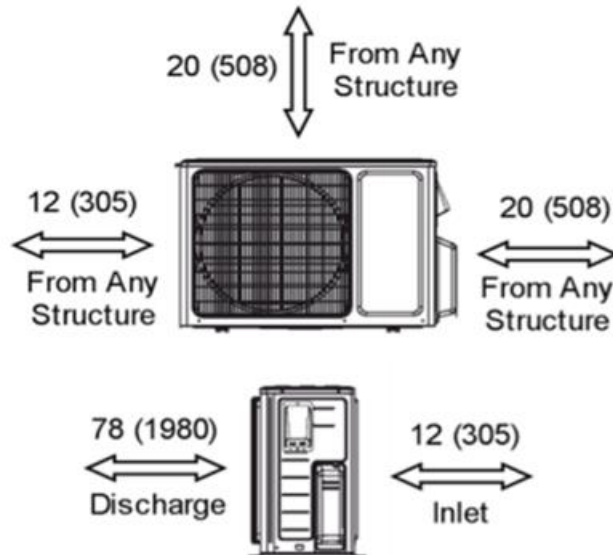

## DIMENSIONAL SPECIFICATIONS

### INDOOR UNIT DIMENSIONS

Units: inch

Model No: LIVS24HP230V1BH

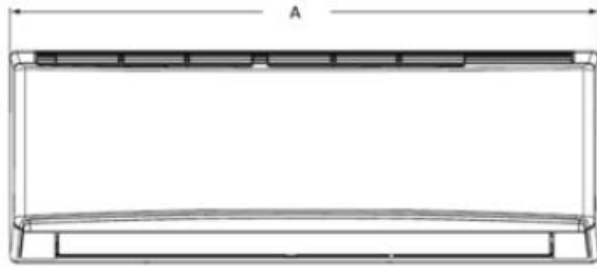

Dimensions	
A	42.4
B	12.8
C	9.7

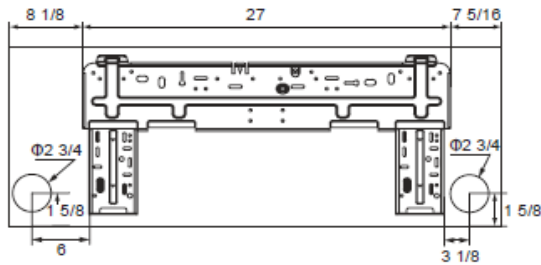

Weight (Net/Gross) 37.5/45.2 lbs

Liquid Line Valve	1/4-in OD Flared
Gas Line Valve	5/8-in OD Flared
Drain Connector	5/8-in OD

### OUTDOOR UNIT DIMENSIONS

Units: inch

Model No: LIVS24HP230V1BO

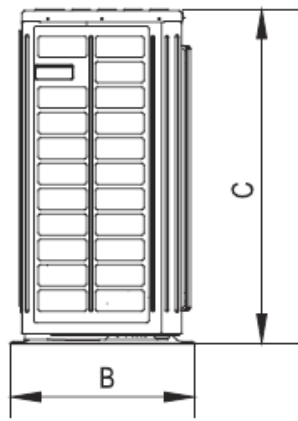
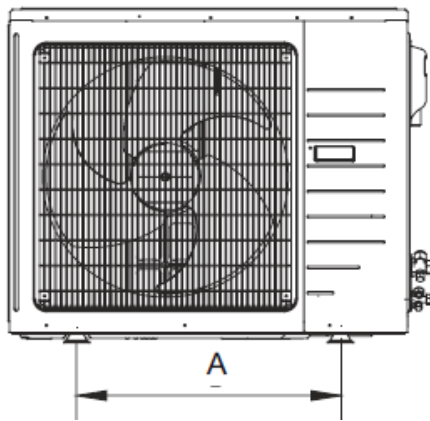

Dimensions	
A	22.0
B	15.3
C	27.6
D	38.0
E	14.3

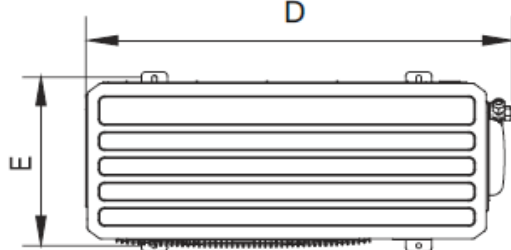

Weight (Net/Gross) 110.3/120.2 lbs

Liquid Line Valve	1/4-in OD Flared
Gas Line Valve	5/8-in OD Flared

**Notes:**

1. Recommended Interconnecting Cable Type 14 AWG 4 Stranded Copper Conductors THHN 600V Wire
2. Power wiring cable size must comply with applicable national and local codes.
3. Test conditions are based on AHRI 210/240.